



Cover 2:
Aaron Truffle

Cover 4:
Destiny Silver *

Cover 3:
Tessere Pebble

Cover 5:
Duchess Pebble

Cover 1:
Outback Charcoal
Leather

Antique Feet

* PLEASE NOTE THAT DESTINY FABRIC IS ONLY AVAILABLE AS COVER 4 ON PILLOW BACK AND COVER 3 ON STANDARD BACK.

Valerie Collection

Colours represented are to be used as a guide only.
Please refer to manufacturers swatch for a more accurate colour match.

Please note that colour shadings can vary slightly from each roll of fabric.
We cannot guarantee a precise match to these samples or between cut lengths and upholstered goods.

foamflex™

Award Winning Seating Technology

05/05/2021

VALERIE COVER GUIDE: STANDARD BACK

Please use this guide when ordering the following pieces to clarify cover options.

STANDARD BACK - Available with & without studs

LH2, COR, RH1 (L2, CO, R1)

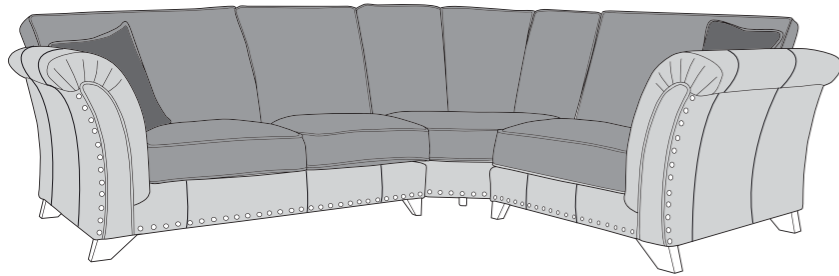

LH1, COR, RH2 (L1, CO, R2)

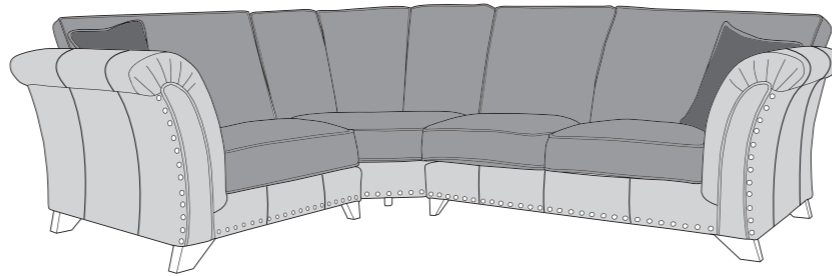

LH1, COR, RH1 (L1, CO, RH)

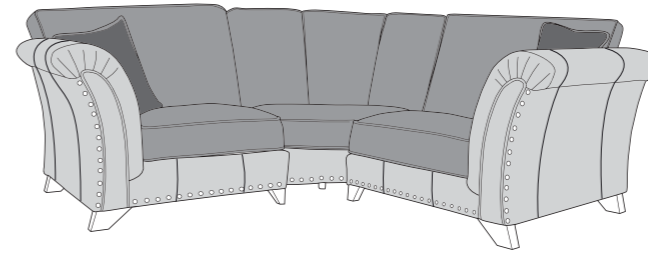

LH2, COR, RH2 (L2, CO, R2)

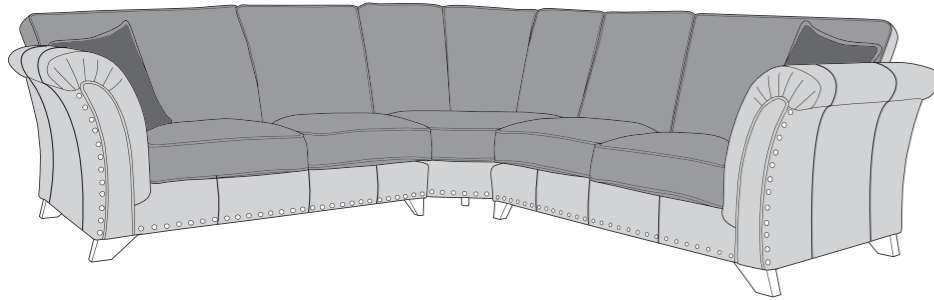

ALU (AU)

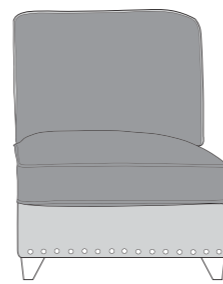

4 Seater Modular Sofa (4MD)

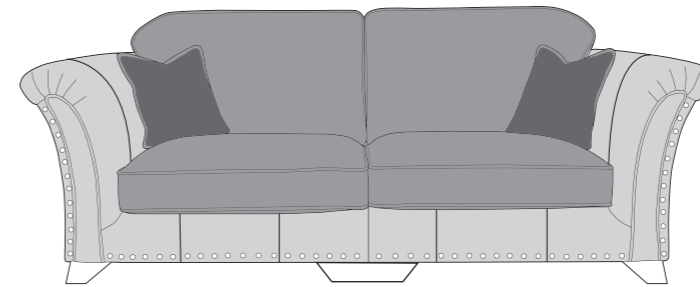

3 Seater Sofa (3ST)

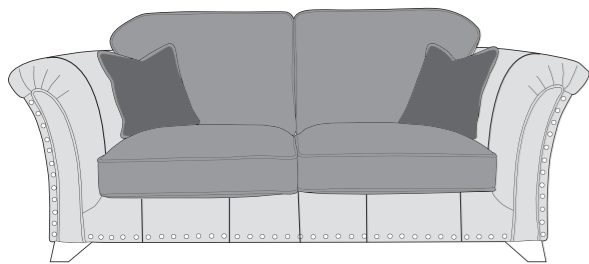

2 Seater Sofa (2ST)

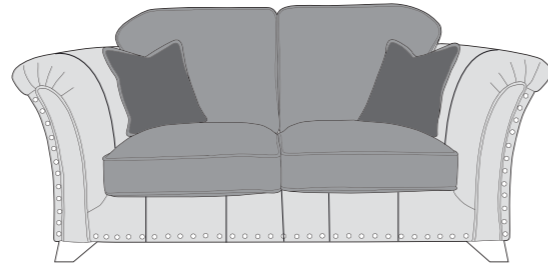

Love Chair (LOV)

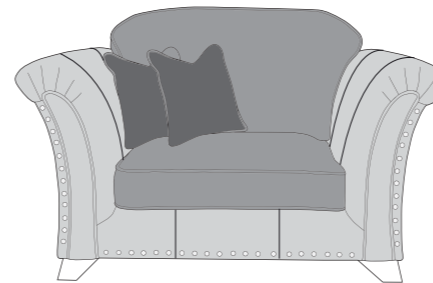

Arm Chair (1ST)

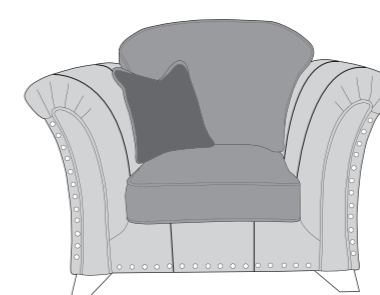

120cm Deluxe Sofa Bed (2DB)

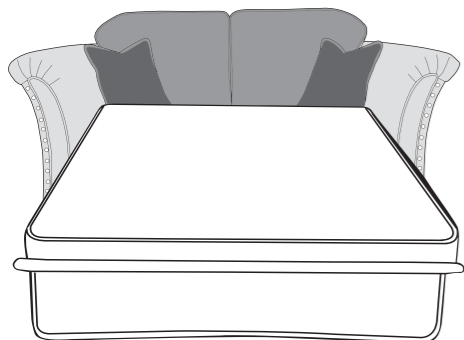

 **COVER 1**
(OUTER LEATHER)

 **COVER 2**
(FABRIC INNER)

 **COVER 3**
(SCATTER)

Standard Back Scatter Cushions

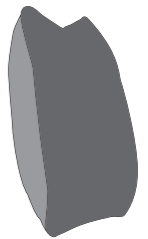

Flanged Edge
Front = Cover 3
Back = Cover 2

 **BFM**
BRITISH FURNITURE
MANUFACTURERS
APPROVED MEMBER

 **A©ID**
ANTI COPYING IN DESIGN

VALERIE COVER GUIDE: PILLOW BACK

Please use this guide when ordering the following pieces to clarify cover options.

PILLOW BACK - Available with & without studs

LH2, COR, RH1 (L2, CO, R1)

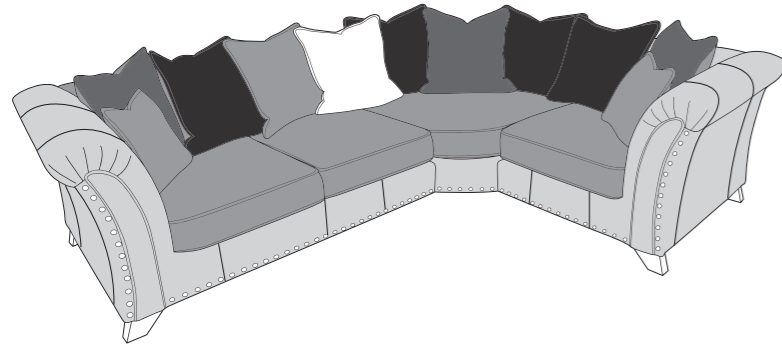

LH1, COR, RH2 (L1, CO, R2)

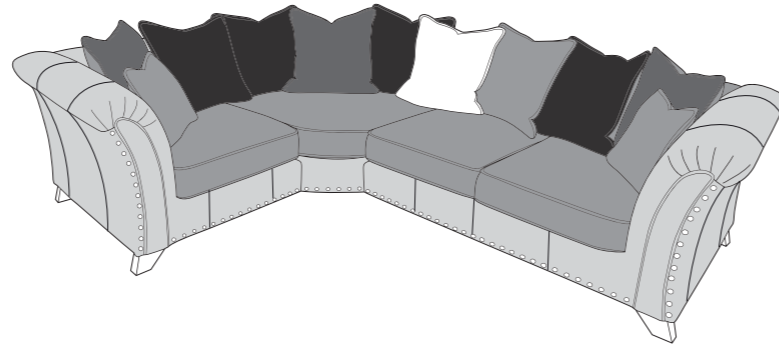

LH1, COR, RH1 (L1, CO, R1)

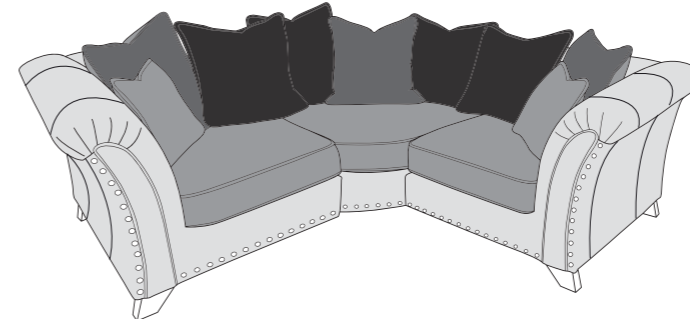

LH2, COR, RH2 (L2, CO, R2)

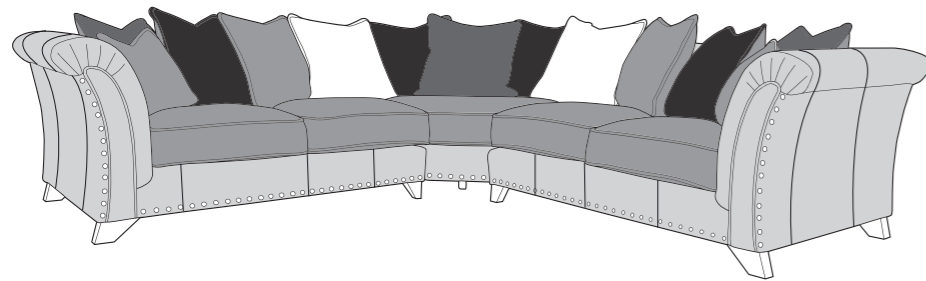

ALU (AU)

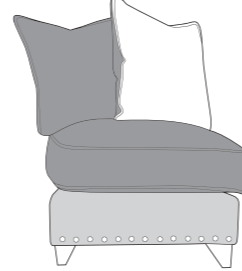

4 Seater Modular Sofa (4MD)

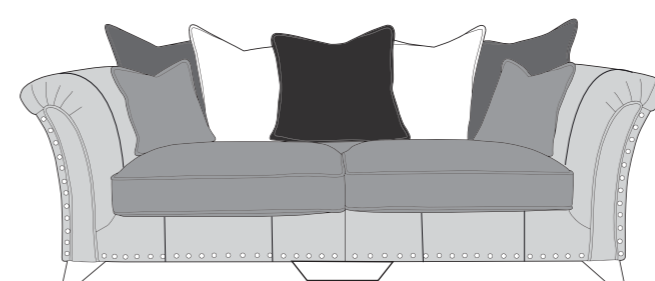

3 Seater Sofa (3ST)

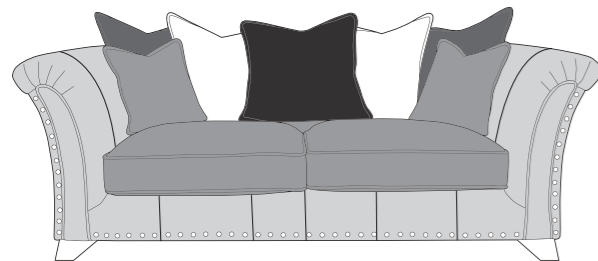

2 Seater Sofa (2ST)

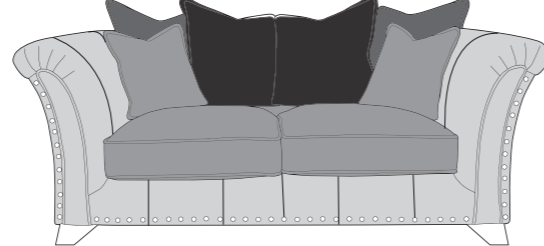





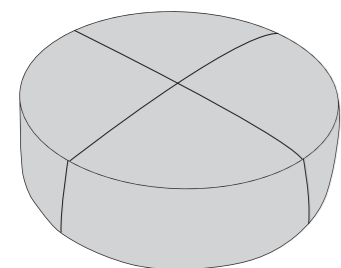

ACCENT PIECES

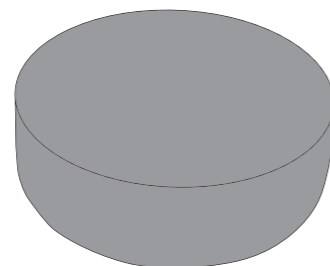
Valetta (Leather)
Footstool (FST)



Vesper (Fabric)
Footstool (FST)



-  **COVER 1**
(OUTER LEATHER)
-  **COVER 2**
(SEATS, PILLOWS & SMALL SCATTER)
-  **COVER 3**
(PILLOW)
-  **COVER 4**
(PILLOW)
-  **COVER 5**
(PILLOW)

Pillow Back Cushions

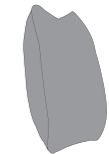

Flanged Edge
Front = Cover 2
Back = Cover 2



Flanged Edge
Front = Cover 3
Back = Cover 2



Flanged Edge
Front = Cover 4
Back = Cover 2



Flanged Edge
Front = Cover 5
Back = Cover 2

Pillow Back Scatter Cushions

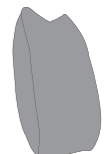

Flanged Edge
Front = Cover 2
Back = Cover 2



VALERIE DIMENSIONS (CM)

AVAILABLE PIECES	HEIGHT 1	OUTBACK HEIGHT	WIDTH 2	DEPTH 3	ARM HEIGHT	SEAT HEIGHT 4	SEAT DEPTH (STANDARD) 5	SEAT DEPTH (PILLOW) 5	SEAT WIDTH 6	ACCESS DIAGONAL 7	WEIGHT (KG)	SCATTER CUSHION NO.
LH1, COR, RH2 or RH1, COR, LH2 CORNER GROUP	92	79	289	223	81	49	N/A	N/A	N/A	117	135.5	2
LH1, COR, RH1 CORNER GROUP	92	79	223	223	81	49	N/A	N/A	N/A	N/A	126	2
LH2, COR, RH2 CORNER GROUP	92	79	289	289	81	49	N/A	N/A	N/A	402	148	2
LH2/RH2 UNIT	92	79	167	104	81	49	52	52	135	194	52.5	1
LH1/RH1 UNIT	92	79	101	104	81	49	52	52	69	141	40	1
ALU - ARMLESS UNIT	92	79	70	104	N/A	49	52	52	70	121	24.5	N/A
COR - CORNER UNIT	92	79	122	122	N/A	49	65	65	N/A	173	43	N/A
4ML/4MR UNIT (4MD)	92	79	126	104	81	49	52	52	94	159	46.5	1
4 SEATER MODULAR SOFA (4MD)	92	79	252	104	81	49	52	52	188	273	93	2
3 SEATER SOFA (3ST)	92	79	219	104	81	49	52	52	155	239	76.5	2
2 SEATER SOFA (2ST)	92	79	200	104	81	49	52	52	136	220	66	2
LOVE CHAIR (LOV)	92	79	158	104	81	49	52	52	91	158	55.5	2
ARM CHAIR (1ST)	92	79	128	104	81	49	52	52	62	160	49.5	1
ACCENT PIECES												
VESPER FOOTSTOOL (FST)	33	N/A	97	97	N/A	N/A	N/A	N/A	N/A	97	22	N/A
VALETTA FOOTSTOOL (FST)	33	N/A	97	97	N/A	N/A	N/A	N/A	N/A	97	22	N/A
SOFA BEDS												
120CM DELUXE SOFA BED (2DB)	96	79	202	104	80	53	65	N/A	136	220	102	2

SOFABED:

DELUXE ACTION & SPRUNG MATTRESS

A two fold metal action with beech slats.

Complemented by a deluxe sprung mattress.

For everyday use.

Mattress thickness: 11.5cm

Mattress Length: 183cm

2 fold action is 160Kg total max occupancy weight



120cm sofa bed:

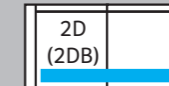

Mattress Width: 114cm

Sofa beds available as standard back only

- * Hardwood & composite board frame.
- * Dowelled, screwed, glued & stapled joinery.
- * Light & Dark Wood foot options.

- * Fibre filled Standard backs for added comfort.
- * Feather filled scatter backs and scatters included. 
- * Award winning foamflex seat interior with 5 year guarantee.

- * Serpentine seat springs & silent wire.
- * Elasticated back webbing.
- * Full Leather / No Splits 

DIMENSION GUIDE

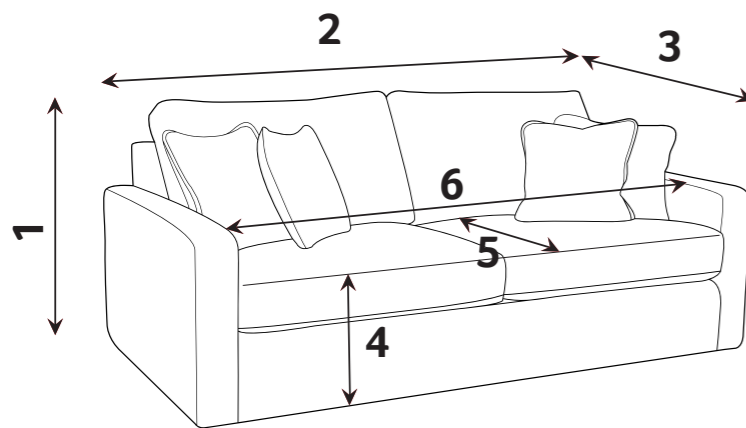

1 - HEIGHT
2 - WIDTH

3 - DEPTH
4 - SEAT HEIGHT

5 - SEAT DEPTH (STD & PILLOW)
6 - SEAT WIDTH

7 - DIAGONAL ACCESS

Check the diagonal access dimension to ensure furniture will fit in your home.

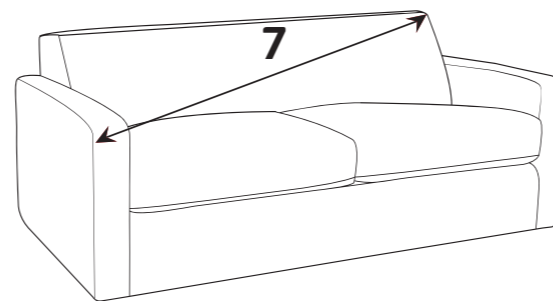

Illustrations used for reference only.

foamflex™

Our new expertly engineered foam seat interior gives you the comfort of fibre with the retention of foam.

CARE GUIDE

To improve the longevity of your hand-made furniture, we recommend rotating cushions (where applicable).

For further information on maintaining your furniture, please refer to the Care Guide located under the seat platform.



Our foamflex seat interiors have been granted the FIRA GOLD Award, a mark of quality under-pinning all necessary testing of the product materials, design and production techniques.

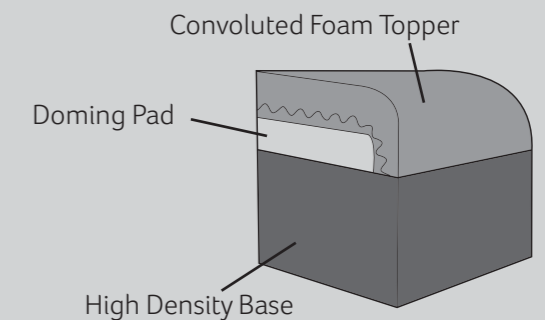

Beech (Light)

4M Centre Foot

Antique (Dark)

4M Centre Foot

SOFA BED FEET
Antique (Dark)

Beech (Light)

FOOT OPTIONS:



Please note : All dimensions are approximate. Allow tolerance of +/- 2.5cm.

Wood is a natural product and will vary in shade/colour from item to item. Feet may require fitting.

05/05/2021